



Lithium Iron Phosphate (LiFePO4) Battery

EV12.8-40 (12.8V40AH/2HR)

Features of LiFePO4 Battery

Longer cycle life: Up to 2000 times longer cycle life and five times longer float/calendar life than lead acid battery, minimize replacement cost and reduce total cost.

Lighter Weight: About 40% of the weight of a comparable lead acid battery.

Higher Power: Delivers twice power of lead acid battery, even high discharge rate, while maintaining high energy capacity

Wider Temperature Range: -20°C~60°C

Super Safety: Lithium Iron Phosphate Chemistry eliminates the risk of explosion or combustion due to high impact, over charging or short circuit situation.

Increased Flexibility: Modular design enables deployment of up to four batteries in series and up to four batteries in parallel.

Physical Dimension

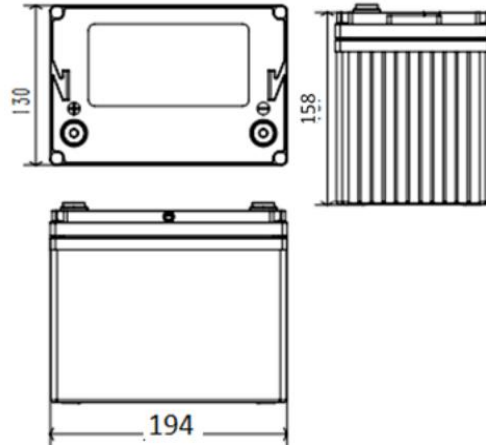

Application:

- * Electric vehicles, electric mobility
- * Solar/wind energy storage system
- * UPS, backup Power
- * Telecommunication
- * Medical equipment
- * Lighting

Specification:

Electrical Characteristics	Nominal Voltage	12.8V
	Nominal Capacity	40AH
	Energy	512Wh
	Internal Resistance	≪28mΩ
	Cycle life	>2000 cycles at 0.2C 100% DOD
	Months Self Discharge	<3%
	Efficiency of Charge	100% at 0.5C
	Efficiency of discharge	96~99% at 1C
Charge	Charge volt	14.6±0.2V
	Charge Mode	CC at 0.2C to 14.6V, then at CV14.6V to charge current less than 0.02C
	Charge Current	8A
	Max. Charge current	20A
	Charge cut off voltage	15.6V±0.2V
Discharge	Max. Continuous Current	40A
	Max. Pulse Current	120A (<30 ms)
	Discharge Cut-off Voltage	10V
Environment	Charge Temperature	0°C to 45°C (32F to 113F) at 60±25% Relative Humidity
	Discharge Temperature	- 20°C to 60°C (-4F to 140F) at 60±25% Relative Humidity
	Storage Temperature	0°C to 40°C (32F to 104F) 60±25% Relative Humidity
	Water Dust Resistance	IP56
Mechanical	Cell material	LiFePO4
	Plastic Case	ABS
	Dimensions (in./mm)	194*130*158mm (7.64**5.12**6.22")
	Weight (lbs./kg.)	5.20KG (11.46 lbs)
	Terminal	M6

Discharge Curve at different rate at 25°C

Discharge Curve at different temperature at 0.5C rate

Different Rate Discharge Curve @25°C

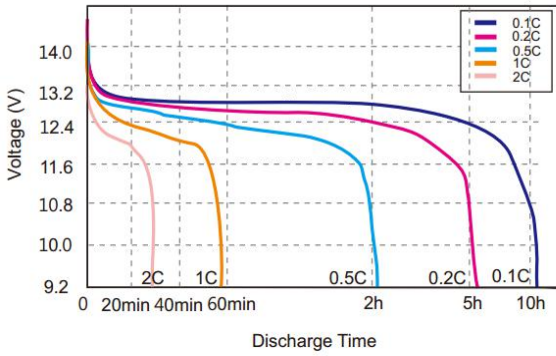

Different Temperature Discharge Curve @0.5C

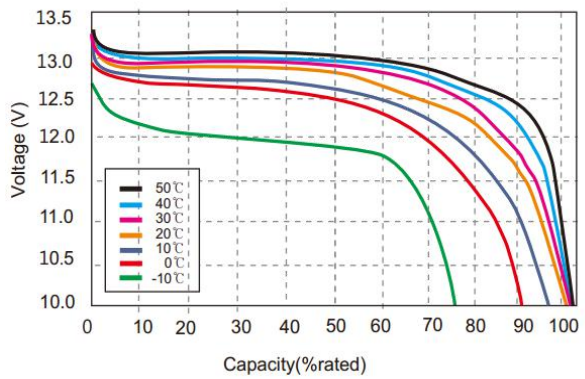

Discharge Curve at different rate at 25°C

Discharge Curve at different rate at 25°C

State of Charge Curve @0.5C 25°C

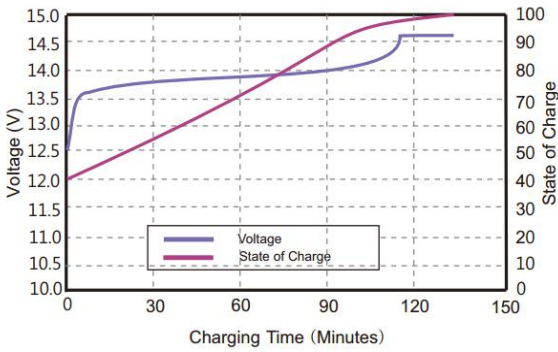

Charging Characteristics @0.5C 25°C

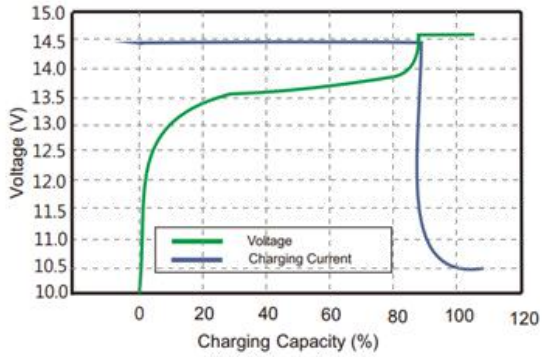

Cycle Life @ Different DOD Discharge at 1C

Different Temperature Self Discharge Curve

Different DOD Discharge Cycle Life Curve @1C

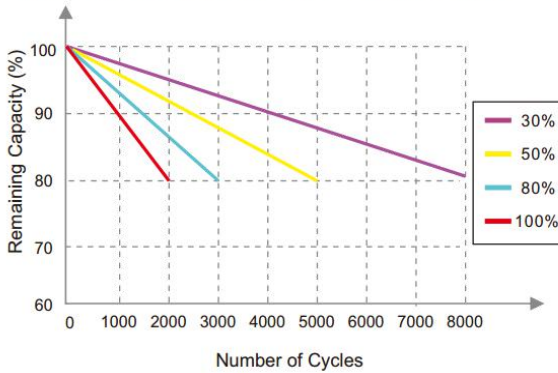

Different Temperature Self Discharge Curve

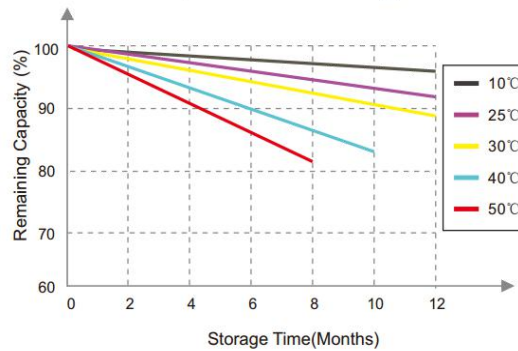

Holy Enterprise Limited: No. 26, Caihong Road, West Dist. Zhongshan City, Guangdong, China

Tel: 86 139 2814 5872 Fax: 0086-760-8862 5562 Web: www.holyener.com Email: sales@hollyener.com